

JUMO GmbH & Co. KG
 Delivery address: Mackenrodtstraße 14,
 36039 Fulda, Germany
 Postal address: 36035 Fulda, Germany
 Phone: +49 661 6003-0
 Fax: +49 661 6003-607
 e-mail: mail@jumo.net
 Internet: www.jumo.net

JUMO Instrument Co. Ltd.
 JUMO House
 Temple Bank, Riverway
 Harlow, Essex CM20 2DY, UK
 Phone: +44 1279 635533
 Fax: +44 1279 635262
 e-mail: sales@jumo.co.uk
 Internet: www.jumo.co.uk

JUMO Process Control, Inc.
 8 Technology Boulevard
 Canastota, NY 13031, USA
 Phone: 315-697-JUMO
 1-800-554-JUMO
 Fax: 315-697-5867
 e-mail: info@jumo.us
 Internet: www.jumo.us



JUMO mTRON T Measuring, Control, and Automation System

Multifunction panel 840

Brief description

The multifunction panel 840 with TFT-touchscreen allows easy and clearly-arranged measured data visualization, operation, configuration, and parameterization of the system.

The TFT color screen has a screen size of 21.3 cm (8.4"), a resolution of 640 x 480 pixels, 256 colors, and LED backlight.

As the interface between man and machine, the panel allows an optimum and clearly-arranged view of the process status and the system parameters. In addition, it is perfectly suitable for the display and operation of controller screens, process screens, the program editor, and the optional recording function. Setpoint values, batch text, parameters, and configuration data can be directly entered and changed by the user on the screen.

The process data that is transmitted by the system bus is shown in real time. Data archiving and evaluation is made possible by established PC-programs.

In addition to the standard interfaces (LAN, USB), two optional serial interfaces can be connected to a barcode scanner, modem, or other Modbus devices (master, slave).

The user can comfortably configure the multifunctional panel 840 with the setup program. And many functions are also configurable directly on the multifunction panel 840.



Type 705060/...

Block diagram

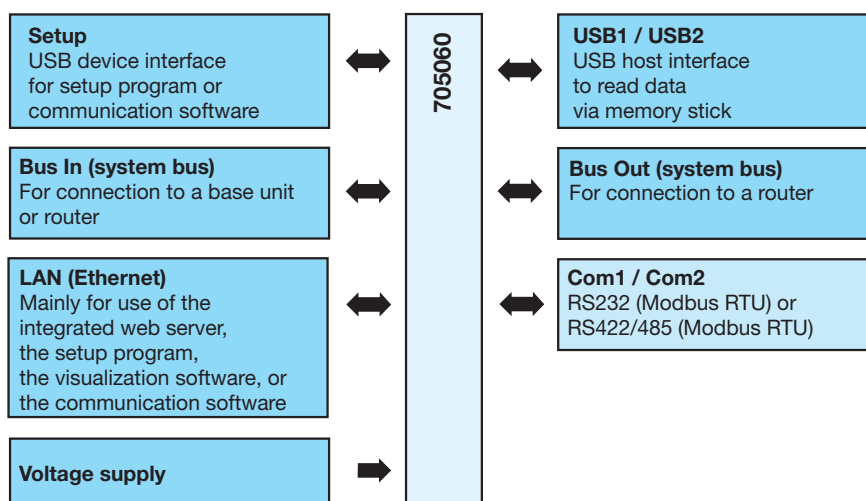

Features

- TFT-touchscreen 21.3 cm (8.4") with 640 x 480 pixel resolution and 256 colors
- Predefined screen masks for controllers, program generators, and recording functions
- Customized process screens
- User administration
- Configuration of the entire system possible
- Recording function (option)
- Integrated web server
- Ethernet interface
- Three USB interfaces
- Two RJ45 system bus connections (1 x bus In, 1 x bus Out)
- Two serial interfaces (option) as RS232 or RS422/485 for bar code scanner as well as Modbus RTU master/slave
- Sturdy metal case, IP67 protection at the front

Approvals/approval marks (see "Technical data")





Description

The multifunction panel 840 can be used by the user to configure, parameterize, monitor, and operate the measuring, control and automation system. A recording function, as known from the JUMO paperless recorders, is available as an option. The JUMO mTRON T system bus supports one multifunction panel; the prerequisite for using the multifunction panel is an installed central processing unit.

Standard functions

Start screen (e. g. process screen)

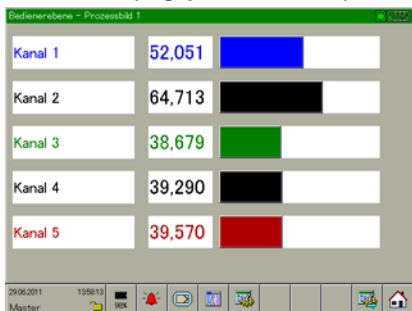

- Selectable start screen
- Operation via symbol bar
- Screen switch-off
- User-specific visualizations
- User level

Configuration of the modules

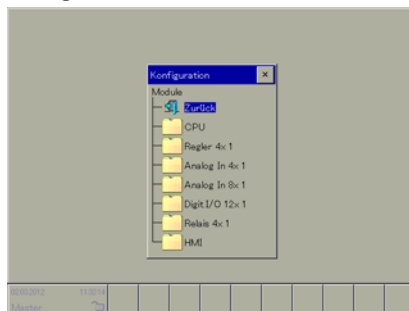

- Online configuration of all input/output modules

Example: Controller module

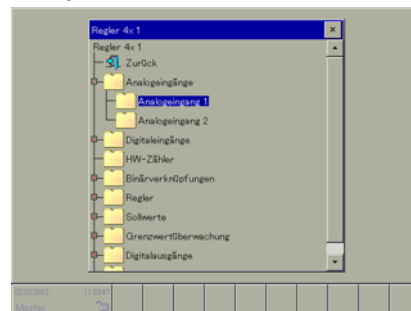

- Inputs/outputs
- Controller type
- Self-optimization
- Special functions for the plastics processing industry
- Setpoint values
- Limit value monitoring

Visualization of the controller channels

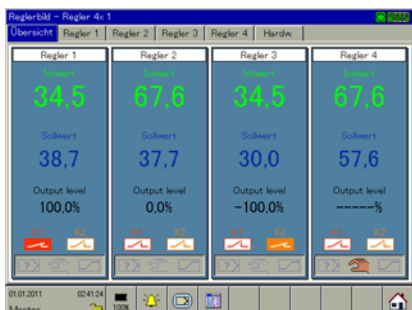

- Up to four controller channels per controller module
- Overview of the active control variables
- Online editing of the setpoint values

Single controller channel



- Overview of the active control variables
- Online editing of the setpoint values
- Manual start of the self-optimization and the manual mode

Controller module



- Overview of the active inputs and outputs
- Overview of the active control variables

Process mask

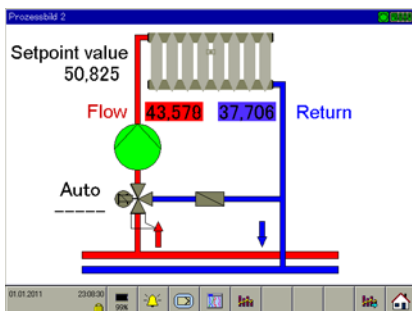

- 18 customer-specific process screens
- Freely configurable display (via setup program) of process values

Batch protocolling

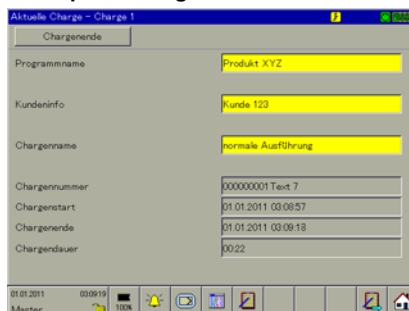

- Simultaneous recording of nine batches
- Toggling between current and completed batch protocols
- Batch texts are readable via interface and bar code scanner (among other methods)

Completed batch protocols



- Graphical data evaluation
- Numerical data evaluation

JUMO GmbH & Co. KG
 Delivery address: Mackenrodtstraße 14,
 36039 Fulda, Germany
 Postal address: 36035 Fulda, Germany
 Phone: +49 661 6003-0
 Fax: +49 661 6003-607
 e-mail: mail@jumo.net
 Internet: www.jumo.net

JUMO Instrument Co. Ltd.
 JUMO House
 Temple Bank, Riverway
 Harlow, Essex CM20 2DY, UK
 Phone: +44 1279 635533
 Fax: +44 1279 635262
 e-mail: sales@jumo.co.uk
 Internet: www.jumo.co.uk

JUMO Process Control, Inc.
 8 Technology Boulevard
 Canastota, NY 13031, USA
 Phone: 315-697-JUMO
 1-800-554-JUMO
 Fax: 315-697-5867
 e-mail: info@jumo.us
 Internet: www.jumo.us



User level

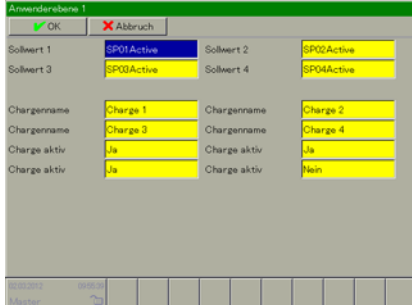

- Important parameters user-specifically summarized in one window
- Less time required for configuration and parameterization

Operator level

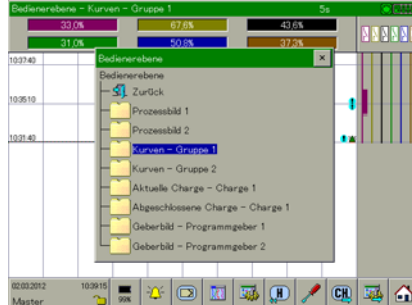

- Important visualizations user-specifically summarized in one operator level

Web server

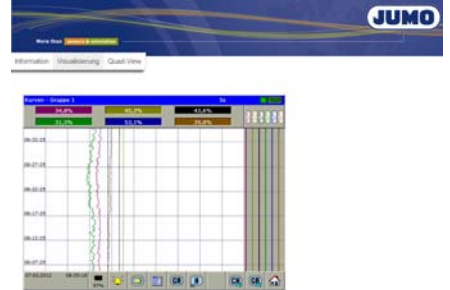

- Integrated web server
- Simultaneous access by several PCs possible
- User-specific pages

Alarm and event lists

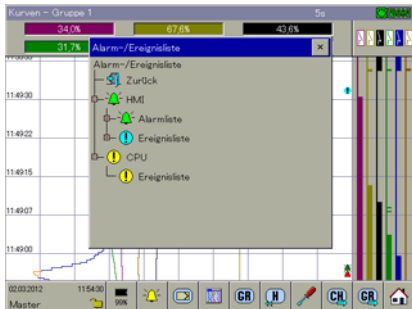

- Alarms of the multifunction panel
- Events of the multifunction panel
- Events of the central processing unit

Example: Multifunction panel 840

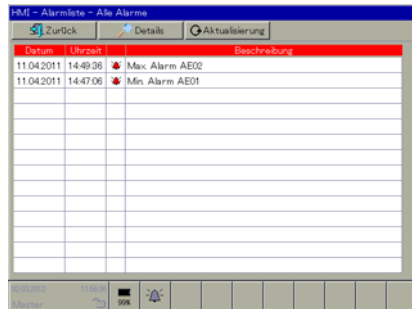

- Alarm when specific limits are exceeded
- All texts can be adjusted
- Alarms and events batch-related or overall overview

Example: Base unit

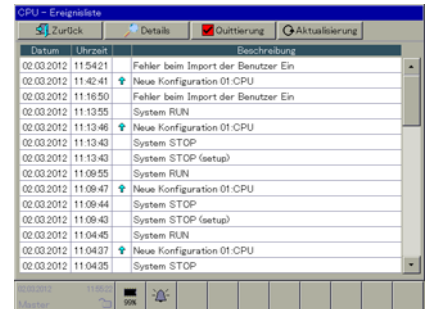

- Events of the base unit (central processing unit)
- All texts can be adjusted

Information about the modules

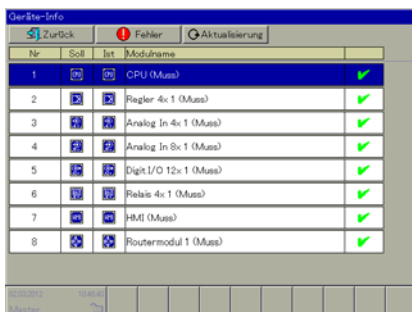

- Overview of the connected modules
- Easy module selection by touching the touchscreen

Example: Analog controller inputs

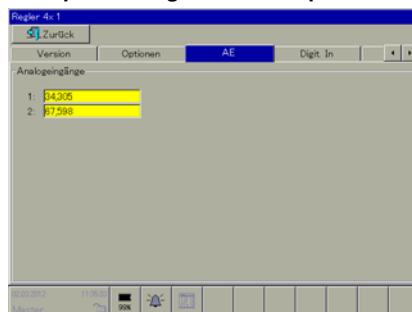

- Overview of a controller module
- All signals, distributed to various tabs

Example: Multifunction panel 840

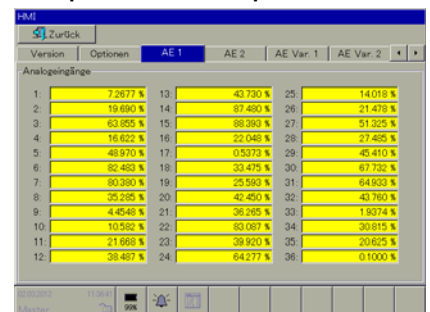

- Overview of the multifunction panel
- All signals, distributed to various tabs



Recording function (option)

Due to the recording function (extra code), the multifunction panel 840 becomes a real paperless recorder, which not only records analog and digital channels but also all controller variables and controller signals. Channels of Modbus slave devices can be integrated into the system and recorded via a Modbus interface and the corresponding Modbus master function.

As of system version 03, analog and digital channels can also be displayed horizontally. The header rows of the vertical presentation (channel name, analog value, switch symbol) are then shown on the right of the analog and digital traces.

Visualization

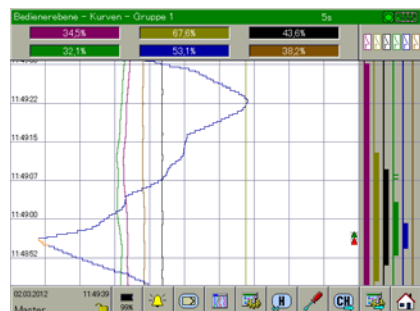

- Visualization of the data in various diagrams (curves, bargraph, text screen, digital, report, counters/integrators)
- Recording of 54 analog channels, 54 digital channels, 27 counters/integrators
- Summary of the channels in nine groups

Bargraph screen

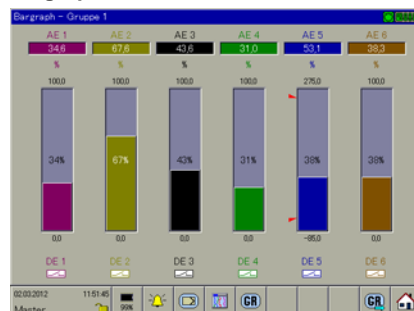

- Display of the analog channels with scaling and limit values in bargraph form
- Bargraphs change color when limit values are exceeded/undercut

Text screen

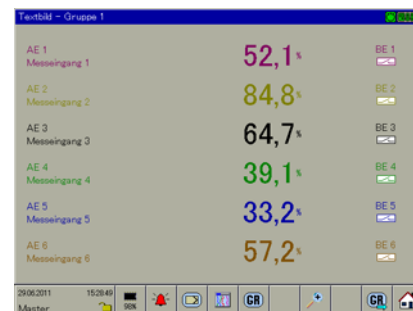

- Numerical display of the measured values
- Values change color when limit values are exceeded/undercut
- Enlarged display of one channel along with a bargraph display is possible

Digital image

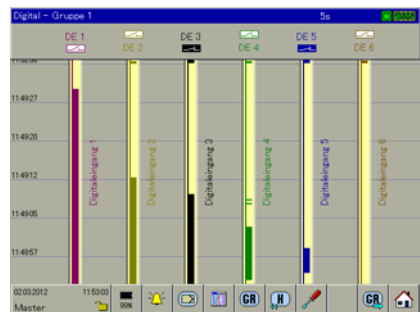

- ON/OFF display of the digital channels
- As of system version 03 horizontal presentation also possible

Report

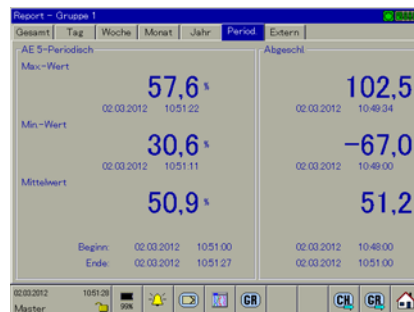

- Display of various reports dealing with the analog channels of one group
- Display of minimum, maximum, average/integral value, and time period

Counters / integrators



- Display of up to 27 counters or integrators
- Toggling between individual and overall display
- Display of the current counter reading and the last completed counter reading

Comment

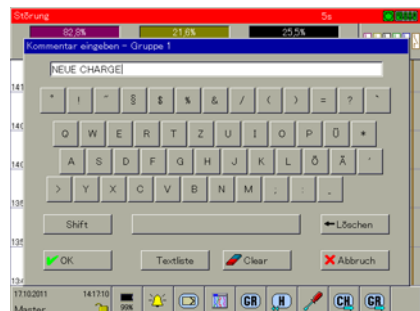

- Input of user-specific comments with on-screen keyboard
- Overview in the event lists of the multifunction panel

History

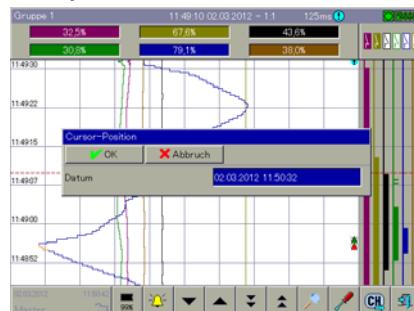

- Curve representation of all measured data saved in the multifunction panel in different zoom stages
- Display of scaling and limit value marks of a channel
- Numerical display of the analog measured values at the cursor position
- Search function

Horizontal presentation

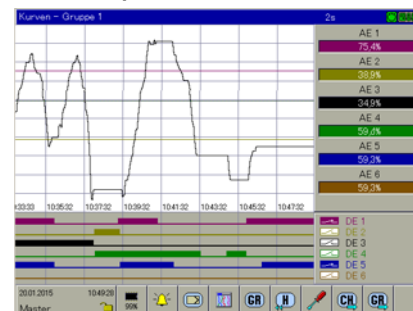

- Horizontal presentation of analog and digital channels with and without header rows
- Individual configuration for each group
- Available as of system version 03

JUMO GmbH & Co. KG
 Delivery address: Mackenrodtstraße 14,
 36039 Fulda, Germany
 Postal address: 36035 Fulda, Germany
 Phone: +49 661 6003-0
 Fax: +49 661 6003-607
 e-mail: mail@jumo.net
 Internet: www.jumo.net

JUMO Instrument Co. Ltd.
 JUMO House
 Temple Bank, Riverway
 Harlow, Essex CM20 2DY, UK
 Phone: +44 1279 635533
 Fax: +44 1279 635262
 e-mail: sales@jumo.co.uk
 Internet: www.jumo.co.uk

JUMO Process Control, Inc.
 8 Technology Boulevard
 Canastota, NY 13031, USA
 Phone: 315-697-JUMO
 1-800-554-JUMO
 Fax: 315-697-5867
 e-mail: info@jumo.us
 Internet: www.jumo.us



Program generator (option)

The optional nine program generators (extra code of the central processing unit) can be configured and operated by the user via the multifunction panel 840.

Overview of all program generators

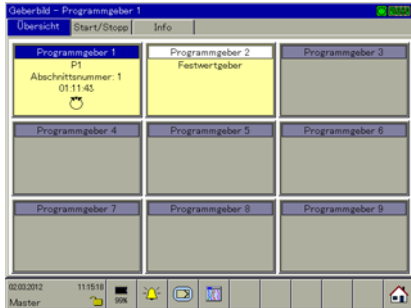

- Display of the allocated and free program generators

Operation of the program generators



- Program selection
- Starting/stopping programs
- Activating manual mode

Creating your own programs



- Creating and changing programs with the integrated program editor

JUMO GmbH & Co. KG
 Delivery address: Mackenrodtstraße 14,
 36039 Fulda, Germany
 Postal address: 36035 Fulda, Germany
 Phone: +49 661 6003-0
 Fax: +49 661 6003-607
 e-mail: mail@jumo.net
 Internet: www.jumo.net

JUMO Instrument Co. Ltd.
 JUMO House
 Temple Bank, Riverway
 Harlow, Essex CM20 2DY, UK
 Phone: +44 1279 635533
 Fax: +44 1279 635262
 e-mail: sales@jumo.co.uk
 Internet: www.jumo.co.uk

JUMO Process Control, Inc.
 8 Technology Boulevard
 Canastota, NY 13031, USA
 Phone: 315-697-JUMO
 1-800-554-JUMO
 Fax: 315-697-5867
 e-mail: info@jumo.us
 Internet: www.jumo.us



Technical data

Interfaces

USB device interface Connector designation Connector type Number Application Max. current	Setup Mini-B 1 To operate the setup program 100 mA
USB host interface Connector designation Connector type Number Application Max. current	USB1 and USB2 A 2 For reading out data via memory stick 100 mA
System bus In Connector designation Connector type Number Application Connection cable Cable length	Bus In RJ45 1 For connection of a base unit or router module Network cable (patch cable or crossover cable), at least CAT5 (S/FTP) Up to 100 m
System bus Out Connector designation Connector type Number Application Connection cable Cable length	Bus Out RJ45 1 For connection of a router module Network cable (patch cable or crossover cable), at least CAT5 (S/FTP) Up to 100 m
Ethernet Connector designation Connector type Number Application Protocols Baud rate	LAN RJ45 1 Communication with PC (setup program, data archiving, web server), e-mail server, and Modbus master/slave TCP/IP, HTTP, DHCP, SMTP+POP3, Modbus/TCP 10 Mbit/s, 100 Mbit/s
RS232 or RS422/485 (serial interface) Connector designation Connector type Number Application Protocol Baud rate External inputs (external variables)	Depending on the ordered device version COM1 and COM2 D-Sub 2 Communication with Modbus master/slave, connection of a barcode scanner or modem including alarm transmission/message via text message or e-mail Modbus RTU as master/slave, bar code scanner 9600, 19200, 38400 Via Modbus master/slave functions, 54 analog and 54 digital inputs

JUMO GmbH & Co. KG
 Delivery address: Mackenrodtstraße 14,
 36039 Fulda, Germany
 Postal address: 36035 Fulda, Germany
 Phone: +49 661 6003-0
 Fax: +49 661 6003-607
 e-mail: mail@jumo.net
 Internet: www.jumo.net

JUMO Instrument Co. Ltd.
 JUMO House
 Temple Bank, Riverway
 Harlow, Essex CM20 2DY, UK
 Phone: +44 1279 635533
 Fax: +44 1279 635262
 e-mail: sales@jumo.co.uk
 Internet: www.jumo.co.uk

JUMO Process Control, Inc.
 8 Technology Boulevard
 Canastota, NY 13031, USA
 Phone: 315-697-JUMO
 1-800-554-JUMO
 Fax: 315-697-5867
 e-mail: info@jumo.us
 Internet: www.jumo.us



Screen

Type	Touchscreen TFT color monitor
Size	21.3 cm (8.4")
Resolution	640 x 480 pixels
Number of colors	256 colors
Frame rate	> 150 Hz
Brightness setting	Adjustable on the device
Screen saver (shutdown)	Via waiting time or control signal

Electrical data

Voltage supply	At the case bottom (removable terminal strip, 2-pin with Push-In technology) DC 24 V +25/-20 % SELV 5 %
Connection	
Voltage	
Residual ripple	
Current consumption	Max. 750 mA (at DC 19.2 V)
Power consumption	Max. 15 W
Conductor cross section (voltage supply)	Min. 0.5 mm ² , max. 2.5 mm ² Min. 0.5 mm ² , max. 2.5 mm ² Min. 0.5 mm ² , max. 1.5 mm ² (both strands with the same cross section)
Wire or strand without ferrule	
Strand with ferrule	
2 x strand with twin ferrule with plastic collar	Min. 0.5 mm ² , max. 1.5 mm ² (both strands with the same cross section)
Stripping length	10 mm
Electrical safety	Acc. to DIN EN 61010-1 Overvoltage category III, pollution degree 2
Electromagnetic compatibility	Acc. to DIN EN 61326-1
Interference emission	Class A – only for industrial use –
Interference immunity	Industrial requirements

Case and ambient conditions

Case type	Metal case for mounting into a panel cut-out (indoor use); front with decor foil
Dimensions (W x H x D)	235 mm x 195 mm x 58 mm (without connection elements)
Weight (fully equipped)	Approx. 1.8 kg
Protection type	Front IP67, rear IP20, acc. to DIN EN 60529
Ambient temperature range	-20 to +55 °C
Storage temperature range	-30 to +70 °C
Resistance to climatic conditions	Relative humidity ≤ 90 % annual average without condensation (climatic class 3K3 acc. to DIN EN 60721-3-3 with extended temperature and humidity range)
Site altitude	Up to 2000 m above sea level
Mechanical ambient conditions ^a	Vibration test acc. to DIN EN 50178 Shock test acc. to DIN EN 60068-2-27 Drop test acc. to DIN EN 60068-2-32

^a Test conditions are listed in the System Descripton B 705000.8.

JUMO GmbH & Co. KG

Delivery address: Mackenrodtstraße 14,
36039 Fulda, Germany
Postal address: 36035 Fulda, Germany
Phone: +49 661 6003-0
Fax: +49 661 6003-607
e-mail: mail@jumo.net
Internet: www.jumo.net

JUMO Instrument Co. Ltd.

JUMO House
Temple Bank, Riverway
Harlow, Essex CM20 2DY, UK
Phone: +44 1279 635533
Fax: +44 1279 635262
e-mail: sales@jumo.co.uk
Internet: www.jumo.co.uk

JUMO Process Control, Inc.

8 Technology Boulevard
Canastota, NY 13031, USA
Phone: 315-697-JUMO
1-800-554-JUMO
Fax: 315-697-5867
e-mail: info@jumo.us
Internet: www.jumo.us

**Approval/approval marks**

Approval mark	Testing agency	Certificate/certification number	Inspection basis	Valid for
c UL us	Underwriters Laboratories	E201387	UL 61010-1 (3. Ed.), CAN/CSA-22.2 No. 61010-1 (3. Ed.)	all types
DNV GL	DNV GL	TAA000016N	Class Guideline DNVGL-CG-0339	all types; a power supply unit with DNV GL or GL type approval is required (e.g. type 705090)



Display, operating, and connection elements



- (1) Front with decor foil
- (2) TFT-touchscreen

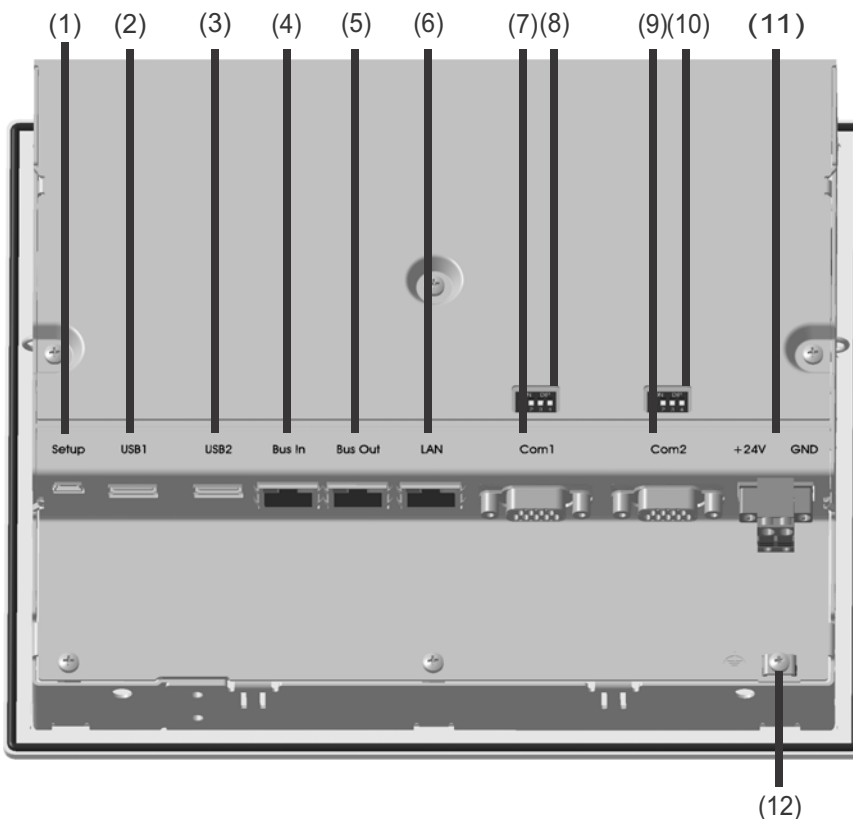

- (1) USB device interface (setup)
- (2) USB host interface 1
- (3) USB host interface 2
- (4) System bus In
- (5) System bus Out
- (6) LAN interface
- (7) Interface Com1
- (8) Termination resistor Com1
- (9) Interface Com2
- (10) Termination resistor, Com2
- (11) Voltage supply In, DC 24 V
- (12) Functional grounding

JUMO GmbH & Co. KG
 Delivery address: Mackenrodtstraße 14,
 36039 Fulda, Germany
 Postal address: 36035 Fulda, Germany
 Phone: +49 661 6003-0
 Fax: +49 661 6003-607
 e-mail: mail@jumo.net
 Internet: www.jumo.net

JUMO Instrument Co. Ltd.
 JUMO House
 Temple Bank, Riverway
 Harlow, Essex CM20 2DY, UK
 Phone: +44 1279 635533
 Fax: +44 1279 635262
 e-mail: sales@jumo.co.uk
 Internet: www.jumo.co.uk

JUMO Process Control, Inc.
 8 Technology Boulevard
 Canastota, NY 13031, USA
 Phone: 315-697-JUMO
 1-800-554-JUMO
 Fax: 315-697-5867
 e-mail: info@jumo.us
 Internet: www.jumo.us



Electrical isolation

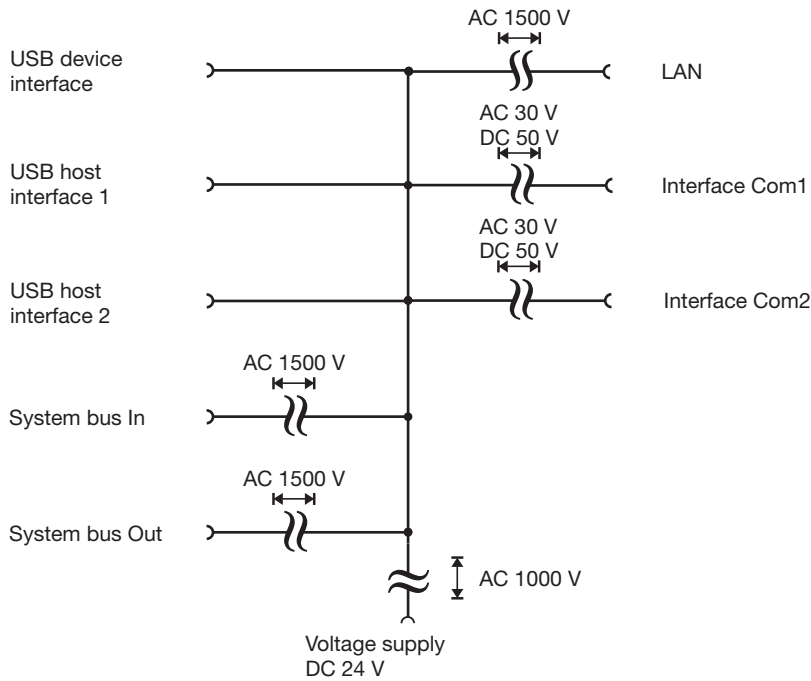

JUMO GmbH & Co. KG
 Delivery address: Mackenrodtstraße 14,
 36039 Fulda, Germany
 Postal address: 36035 Fulda, Germany
 Phone: +49 661 6003-0
 Fax: +49 661 6003-607
 e-mail: mail@jumo.net
 Internet: www.jumo.net

JUMO Instrument Co. Ltd.
 JUMO House
 Temple Bank, Riverway
 Harlow, Essex CM20 2DY, UK
 Phone: +44 1279 635533
 Fax: +44 1279 635262
 e-mail: sales@jumo.co.uk
 Internet: www.jumo.co.uk





JUMO Process Control, Inc.
 8 Technology Boulevard
 Canastota, NY 13031, USA
 Phone: 315-697-JUMO
 1-800-554-JUMO
 Fax: 315-697-5867
 e-mail: info@jumo.us
 Internet: www.jumo.us





Connection diagram

The connection diagram included in the data sheet provides initial information about the connection options. Only use the installation instructions or the operating manual for the electrical connection. The know-how and the correct technical implementation of the safety warnings/instructions contained in these documents are the prerequisite for the installation, electrical connection, and initial start as well as for the safety during operation.

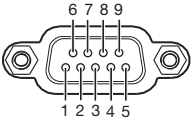
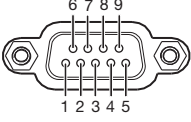
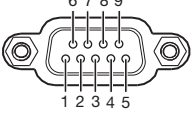
Interfaces

Connection	Designation	Connection element		
USB device	Setup			
USB host	USB1, USB2			
System bus In, System bus Out	Bus In, Bus Out		1 TX+ 2 TX- 3 RX+ 6 RX-	Transmit data + Transmit data - Receive data + Receive data -
Ethernet	LAN		1 TX+ 2 TX- 3 RX+ 6 RX-	Transmit data + Transmit data - Receive data + Receive data -
Serial interface (RS232), optional	Com1, Com2		2 RxD 3 TxD 5 GND	Receive data Transmit data Ground
Serial interface (RS422), optional	Com1, Com2		3 TxD+ 4 RxD+ 5 GND 8 TxD- 9 RxD-	Transmit data + Receive data + Ground Transmit data - Receive data -
Serial interface (RS485), optional	Com1, Com2		3 TxD+/RxD+ 5 GND 8 TxD-/RxD-	Transmit/receive data + Ground Transmit/receive data -

Voltage supply

Connection	Terminals	Symbol and terminal designation	
24 V DC	+24 V and GND	 +	+24 V
		U_x	
		 -	GND

JUMO GmbH & Co. KG
Delivery address: Mackenrodtstraße 14,
36039 Fulda, Germany
Postal address: 36035 Fulda, Germany
Phone: +49 661 6003-0
Fax: +49 661 6003-607
e-mail: mail@jumo.net
Internet: www.jumo.net

JUMO Instrument Co. Ltd.
JUMO House
Temple Bank, Riverway
Harlow, Essex CM20 2DY, UK
Phone: +44 1279 635533
Fax: +44 1279 635262
e-mail: sales@jumo.co.uk
Internet: www.jumo.co.uk

JUMO Process Control, Inc.
8 Technology Boulevard
Canastota, NY 13031, USA
Phone: 315-697-JUMO
1-800-554-JUMO
Fax: 315-697-5867
e-mail: info@jumo.us
Internet: www.jumo.us



Dimensions

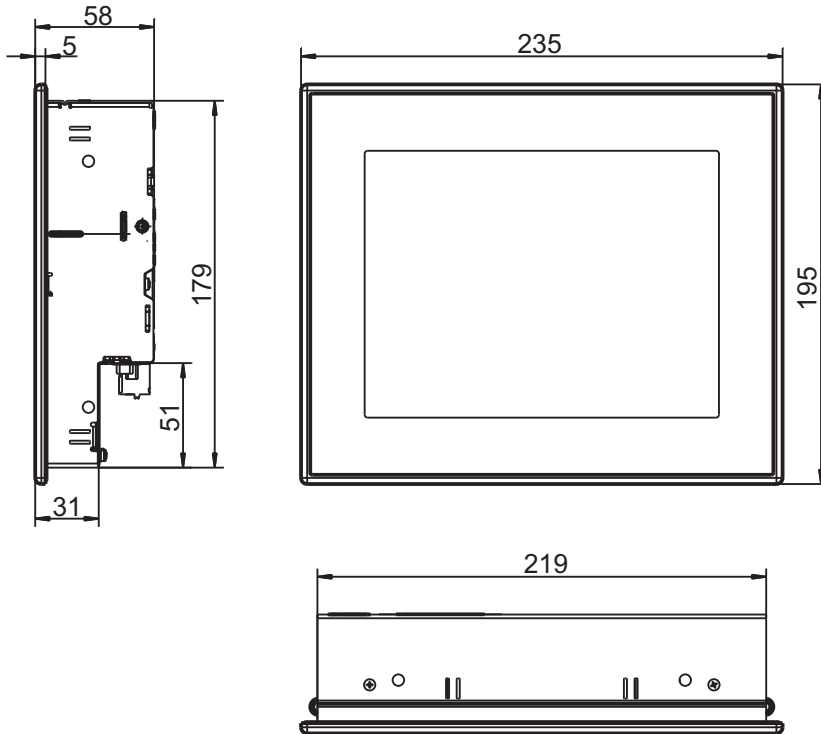

Module overview

Base units

- Central processing unit
Data sheet 705001

Input/output modules

- Multichannel controller module
Data sheet 705010
- Relay module 4-channel
Data sheet 705015
- Analog input module 4-channel
Data sheet 705020
- Analog input module 8-channel
Data sheet 705021
- Analog output module 4-channel
Data sheet 705025
- Digital input/output module 12-channel
Data sheet 705030
- Thyristor power controller type 70906x
Data sheet 709061, 709062, 709063

Special modules

- Router module
Data sheet 705040

Operating, visualization, recording

- Multifunction panel 840
Data sheet 705060
- Operating panels
Data sheet 705065

Power supply units

- 705090/05-33
Data sheet 705090
- 705090/10-33
Data sheet 705090

JUMO GmbH & Co. KG
 Delivery address: Mackenrodtstraße 14,
 36039 Fulda, Germany
 Postal address: 36035 Fulda, Germany
 Phone: +49 661 6003-0
 Fax: +49 661 6003-607
 e-mail: mail@jumo.net
 Internet: www.jumo.net

JUMO Instrument Co. Ltd.
 JUMO House
 Temple Bank, Riverway
 Harlow, Essex CM20 2DY, UK
 Phone: +44 1279 635533
 Fax: +44 1279 635262
 e-mail: sales@jumo.co.uk
 Internet: www.jumo.co.uk

JUMO Process Control, Inc.
 8 Technology Boulevard
 Canastota, NY 13031, USA
 Phone: 315-697-JUMO
 1-800-554-JUMO
 Fax: 315-697-5867
 e-mail: info@jumo.us
 Internet: www.jumo.us



Order details

(1) Basic type	
705060	Multifunction panel 840 (1x Ethernet (RJ45), 1x system bus In (RJ45), 1x system bus Out (RJ45), 2x USB host)
(2) Version	
8	Standard, with factory settings
(3) Interface Com1	
00	Not used
51	RS232 Modbus RTU
54	RS422/485 Modbus RTU
(4) Interface Com2	
00	Not used
51	RS232 Modbus RTU
54	RS422/485 Modbus RTU
(5) Voltage supply	
36	DC 24 V +25/-20 %
(6) Extra codes housing	
000	No extra code
444	Stainless steel front with design foil (neutral)
(7) DNV GL approval	
000	Without approval
062	With DNV GL approval ^a
(8) Extra codes	
000	No extra code
213	Recording function

^a The power supply unit used must also have a DNV GL or GL type approval (e.g. type 705090).

	(1)	(2)	(3)	(4)	(5)	(6)	(7)	(8)							
Order code	<input type="text"/>	/	<input type="text"/>	-	<input type="text"/>	-	<input type="text"/>	/	<input type="text"/>	,	<input type="text"/>	,	<input type="text"/>		
Order example	705060	/	8	-	00	-	00	-	36	/	000	,	000	,	213

Scope of delivery

1 multifunction panel 840 in the ordered version
8 mounting elements
1 strain relief for interface cable
1 template for panel cut-out
1 Installation Instructions

Accessories

Description	Part no.
Extra codes (activations):	
Recording function (extra code 213)	00569508
Additional accessories:	
Bar code scanner Gryphon GD4130	00407798
Memory stick USB 2.0 (2 GB) ^a	00505592

^a The specified USB memory stick is tested and designed for industrial use. No liability is assumed for other brands.

JUMO GmbH & Co. KG

Delivery address: Mackenrodtstraße 14,
36039 Fulda, Germany
Postal address: 36035 Fulda, Germany
Phone: +49 661 6003-0
Fax: +49 661 6003-607
e-mail: mail@jumo.net
Internet: www.jumo.net

JUMO Instrument Co. Ltd.

JUMO House
Temple Bank, Riverway
Harlow, Essex CM20 2DY, UK
Phone: +44 1279 635533
Fax: +44 1279 635262
e-mail: sales@jumo.co.uk
Internet: www.jumo.co.uk

JUMO Process Control, Inc.

8 Technology Boulevard
Canastota, NY 13031, USA
Phone: 315-697-JUMO
1-800-554-JUMO
Fax: 315-697-5867
e-mail: info@jumo.us
Internet: www.jumo.us



General accessories

Description	Part no.
JUMO mTRON T system manual, English	00575577
Setup program with program editor JUMO mTRON T (on MiniDVD), incl. USB cable (A-plug to mini-B-plug, 3 m)	00569494
Program editor JUMO mTRON T (on MiniDVD), incl. USB cable (A-plug to mini-B-plug, 3 m)	00622333
PCA3000/PCC JUMO software package	00431884
PC Evaluation Software PCA3000	00431882
Release automatic print for PC Evaluation Software PCA3000	00505548
PCA Communication Software PCC	00431879
Plant Visualization Software JUMO SVS3000: See data sheet 700755	-
USB cable A-plug mini-B-plug 3 m	00506252

Content of the Mini-DVD:

- Setup program with program editor JUMO mTRON T in case of part no. 00569494
- Program editor JUMO mTRON T in case of part no. 00622333
- CODESYS programming software (free version)
- CODESYS Repository Package - Operating panels (free version)
- GSD file JUMO mTRON T - CPU (free version)
- PC Evaluation Software PCA3000 (30-day trial version)
- PCA Communication Software PCC (30-day trial version)
- Documentation in PDF format